

ICP DAS PROFIBUS Total solutions 2012

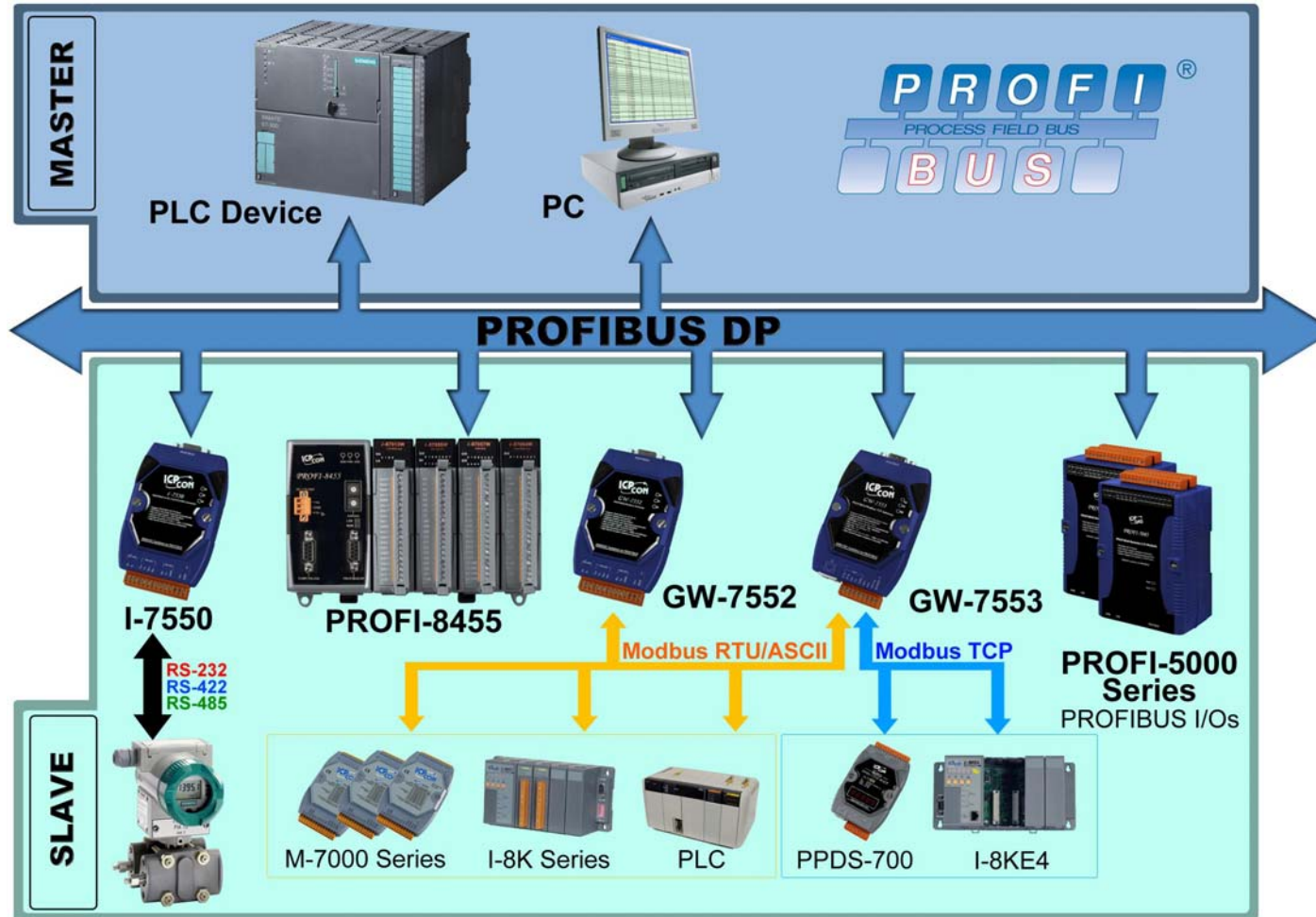

Industrial Computer Product Data Acquisition System

Application Solutions



Industrial Computer Product Data Acquisition System

PROFIBUS Series in ICP DAS



Converter Solution



Gateway Solution



Remote I/O Unit



Remote I/O Module



Industrial Computer Product Data Acquisition System

PROFIBUS Converter Solutions

PROFIBUS Converter, Repeater Products	
I-7550	PROFIBUS to RS-232/422/485 Converter
PROFI-2541	PROFIBUS to Fiber Converter
PROFI-2510	PROFIBUS Repeater



PROFIBUS Converter Solutions

• PROFIBUS to RS-232/422/485 Converter (I-7550)

Feature :

- Protocol & Hierarchy: DP-V0 Slave
- Detect transmission rate (9.6 ~ 12000 kbps) automatically
- COM Port has 100 KB input buffer & 100 KB output buffer
- Max length of in/output data is 128 Bytes
- Address 0~126 set by DIP switch or EEPROM
- Support several kinds of baud rate for COM1 from 1.2 to 115.2 kbps
- 3000 VDC isolation protection on PROFIBUS side
- 4 kV ESD Protection



PROFIBUS Converter Solutions

- PROFIBUS to RS-232/422/485 Converter (I-7550)

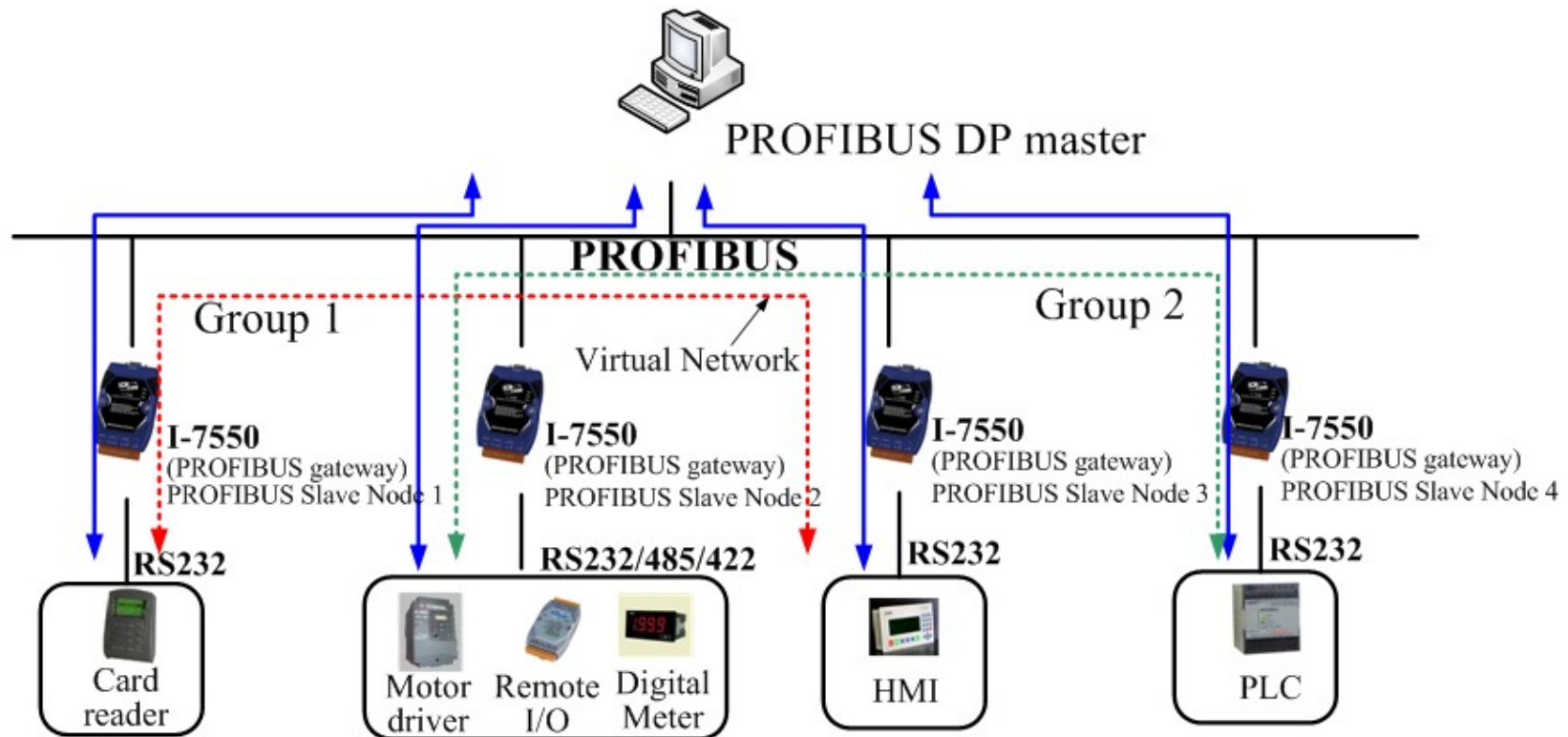

PROFIBUS Converter Solutions

- **PROFIBUS to Fiber Converter (PROFI-2541)**

Feature :

- **Detect transmission rate (9.6 ~ 12000 kbps) on PROFIBUS automatically**
- **Wave Length: 850 nm**
- **Fiber Port: ST (Multi-mode)**
- **Provide status LEDs**
- **2500 Vrms isolation protection on PROFIBUS side**
- **4 kV Contact ESD protection for any terminal**
- **Mount easily on DIN-Rail**



PROFIBUS Converter Solutions

- PROFIBUS to Fiber Converter (PROFI-2541)

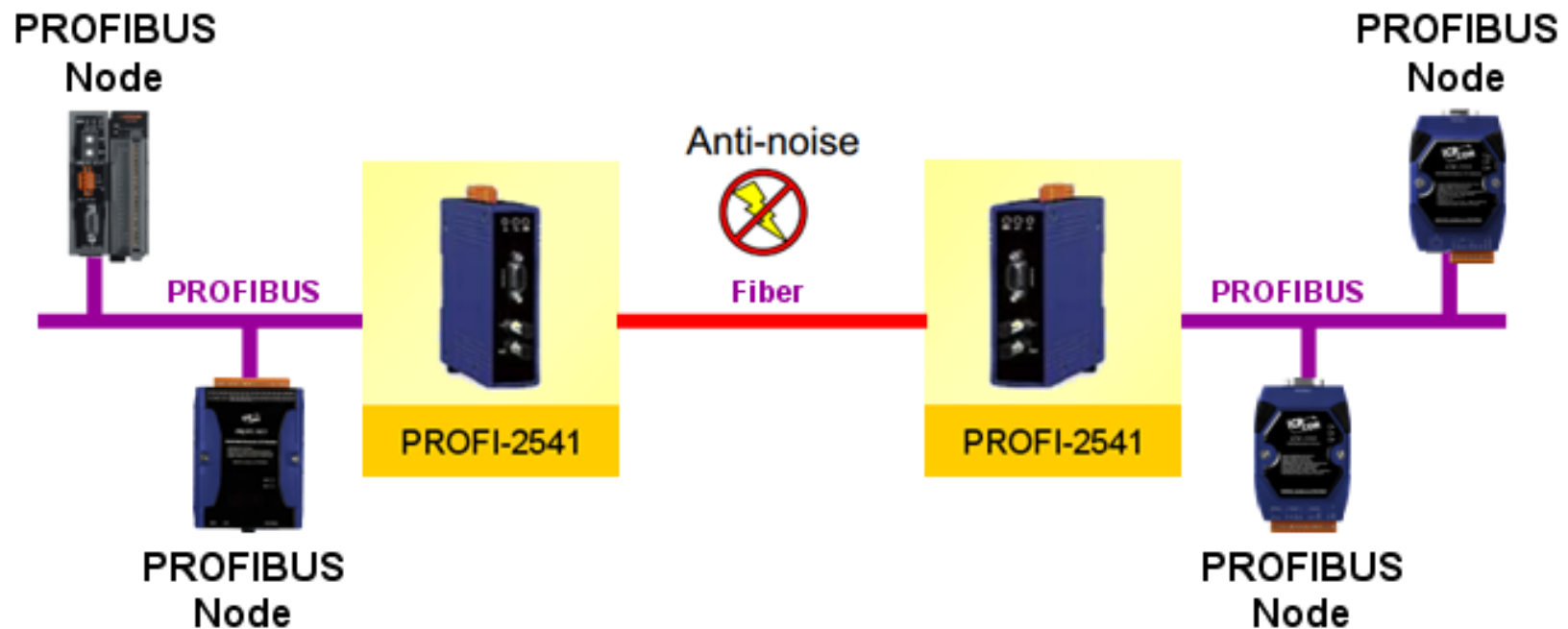

PROFIBUS Converter Solutions

- **PROFIBUS Repeater (PROFI-2510)**

Feature :

- **Detect transmission rate (9.6 ~ 12000 kbps) on PROFIBUS automatically**
- **Can be used as a bus extension or spur line**
- **Increases the number of nodes**
- **Provide status LEDs**
- **2500 Vrms isolation protection on PROFIBUS side**
- **4 kV Contact ESD protection for any terminal**
- **Mount easily on DIN-Rail**



PROFIBUS Converter Solutions

- PROFIBUS Repeater (PROFI-2510)

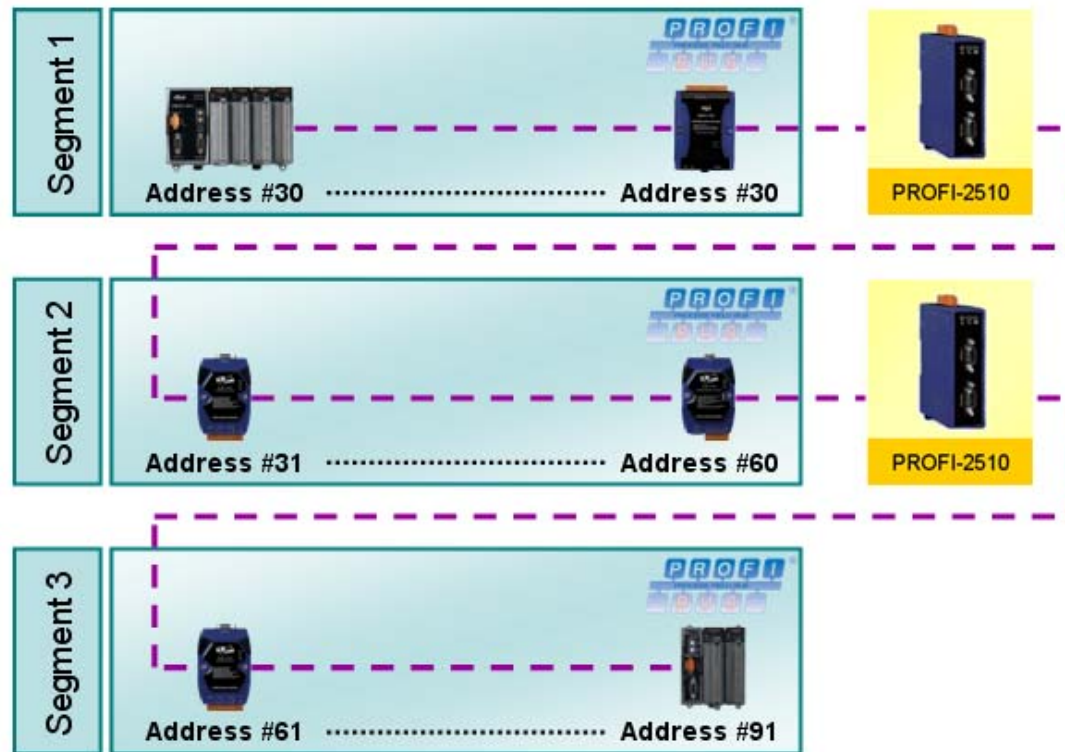

Note:

1. Up to 32 devices per segment
2. Up to 126 addressable nodes per network



PROFIBUS Gateway Solutions

PROFIBUS Gateway Products	
GW-7552	PROFIBUS to Modbus Gateway
GW-7553	PROFIBUS to Modbus TCP Gateway
GW-7557	PROFIBUS to HART Gateway



Industrial Computer Product Data Acquisition System

PROFIBUS Gateway Solutions

- **PROFIBUS to Modbus Gateway (GW-7552)**

Feature :

- **Protocol & Hierarchy: DP-V0 Slave**
- **Detect transmission rate (9.6 ~ 12000 kbps) automatically**
- **128 bytes max input data length**
- **131 bytes max output data length**
- **Support Modbus Master and Slave mode**
- **Support Modbus RTU and ASCII format**
- **Address 0~126 set by DIP switch or EEPROM**
- **Support several kinds of baud rate for COM1 from 2.4 to 115.2 kbps**
- **3000 VDC isolation protection on PROFIBUS side**
- **4 kV ESD Protection**



PROFIBUS Gateway Solutions

- PROFIBUS to Modbus Gateway (GW-7552)

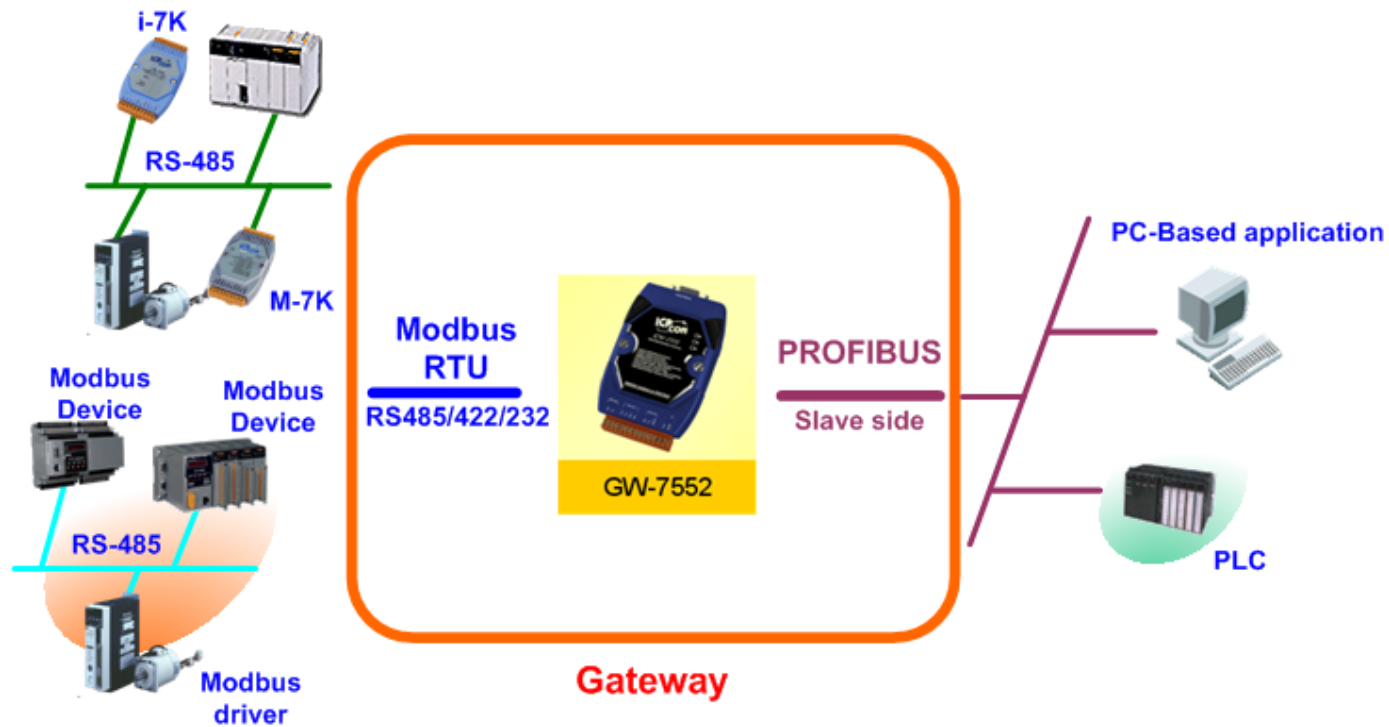

Modbus RTU
Master/Slave Side

PROFIBUS
Master Side



PROFIBUS Gateway Solutions

- **PROFIBUS to Modbus TCP Gateway (GW-7553)**

Feature :

- **Protocol & Hierarchy: DP-V0 & DP-V1 Slave**
- **Detect transmission rate (9.6 ~ 12000 kbps) automatically**
- **240 bytes max input data length**
- **240 bytes max output data length**
- **Support Modbus Master and Slave mode**
- **Support Modbus RTU, ASCII and TCP format**
- **Address 0~126 set by DIP switch or EEPROM**
- **3000 VDC isolation protection on PROFIBUS side**
- **4 kV ESD Protection**



PROFIBUS Gateway Solutions

- PROFIBUS to Modbus TCP Gateway (GW-7553)

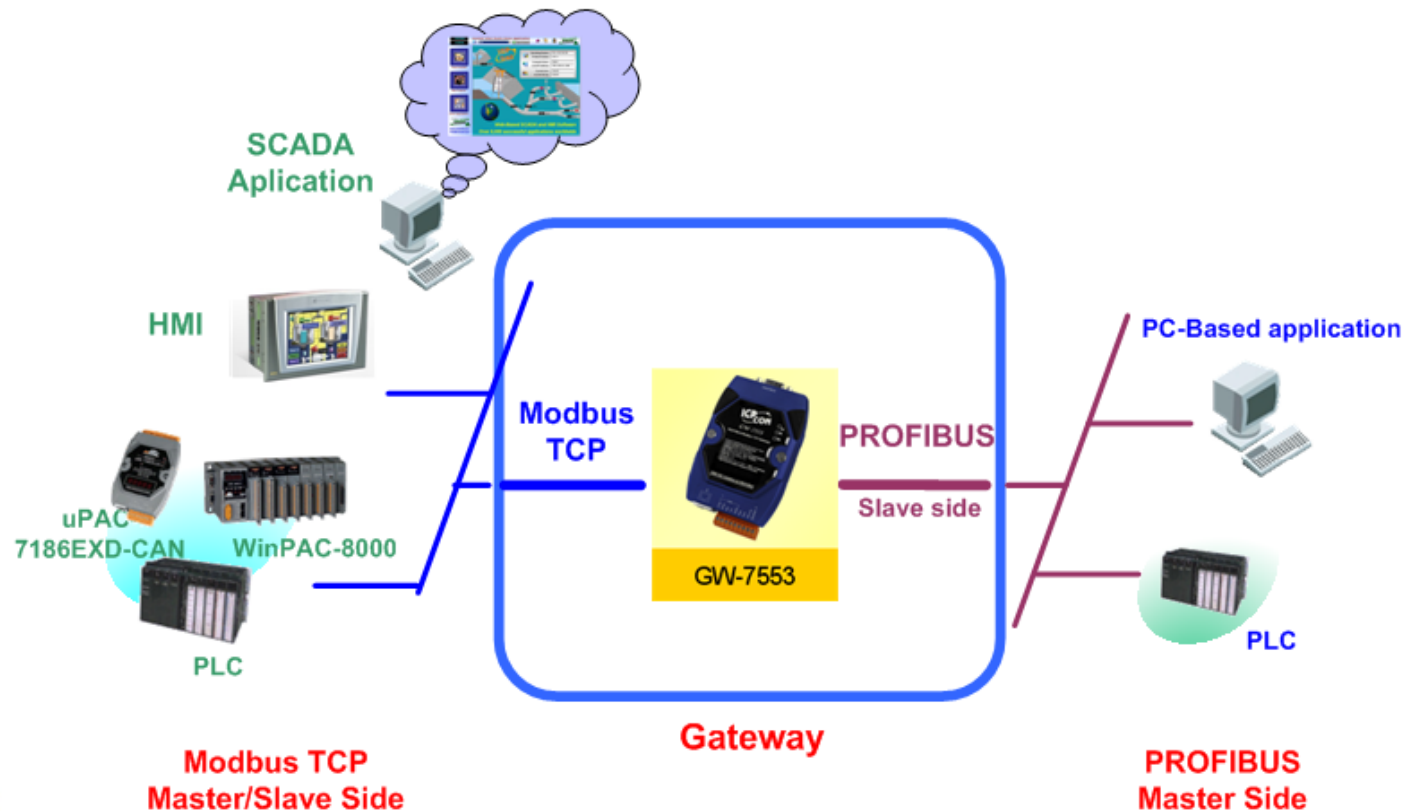

PROFIBUS Gateway Solutions

- **PROFIBUS to HART Gateway (GW-7557)**

Feature :

- **Protocol & Hierarchy: DP-V0 Slave**
- **Detect transmission rate (9.6 ~ 12000 kbps) automatically**
- **240 bytes max input data length**
- **240 bytes max output data length**
- **Allow two HART Masters**
- **Working in point-to-point or multi-drop HART mode**
- **Support 4 HART Channels**
- **3000 VDC isolation protection on PROFIBUS side**
- **4 kV ESD Protection**



PROFIBUS Gateway Solutions

- PROFIBUS to HART Gateway (GW-7557)

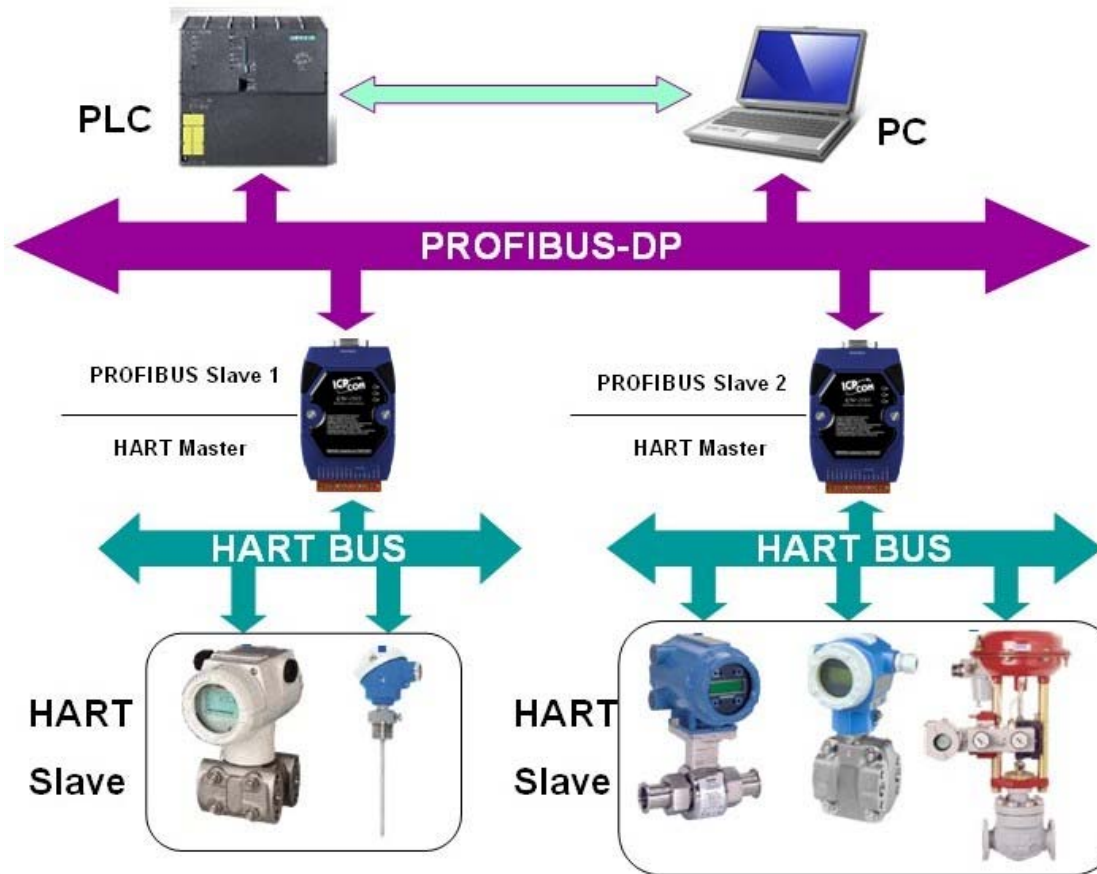

PROFIBUS Remote I/O Unit

PROFIBUS Remote I/O Unit	
PROFI-8155	1 Slot General Purpose PROFIBUS Slave I/O Unit
PROFI-8255	2 Slot General Purpose PROFIBUS Slave I/O Unit
PROFI-8455	4 Slot General Purpose PROFIBUS Slave I/O Unit
PROFI-8855	8 Slot General Purpose PROFIBUS Slave I/O Unit



PROFIBUS Remote I/O Unit

- **PROFI-8x55 Series I/O Unit**

Feature :

- **Protocol & hierarchy: DP-V0 Slave**
- **Detect transmission rate (9.6 ~ 12000 kbps) automatically**
- **Support all I-8k & I-87k I/O Module.**
- **Support Device-Related & Channel-Related Diagnosis.**
- **Address 0~126 set by rotary switches or SSA-Telegram.**
- **Support Hot-Swap for I-87k High-Profile Modules.**
- **3000 VDC isolation protection on PROFIBUS side.**
- **4 kV ESD Protection**



PROFIBUS Remote I/O Unit

- **PROFI-8x55 Series I/O Unit**

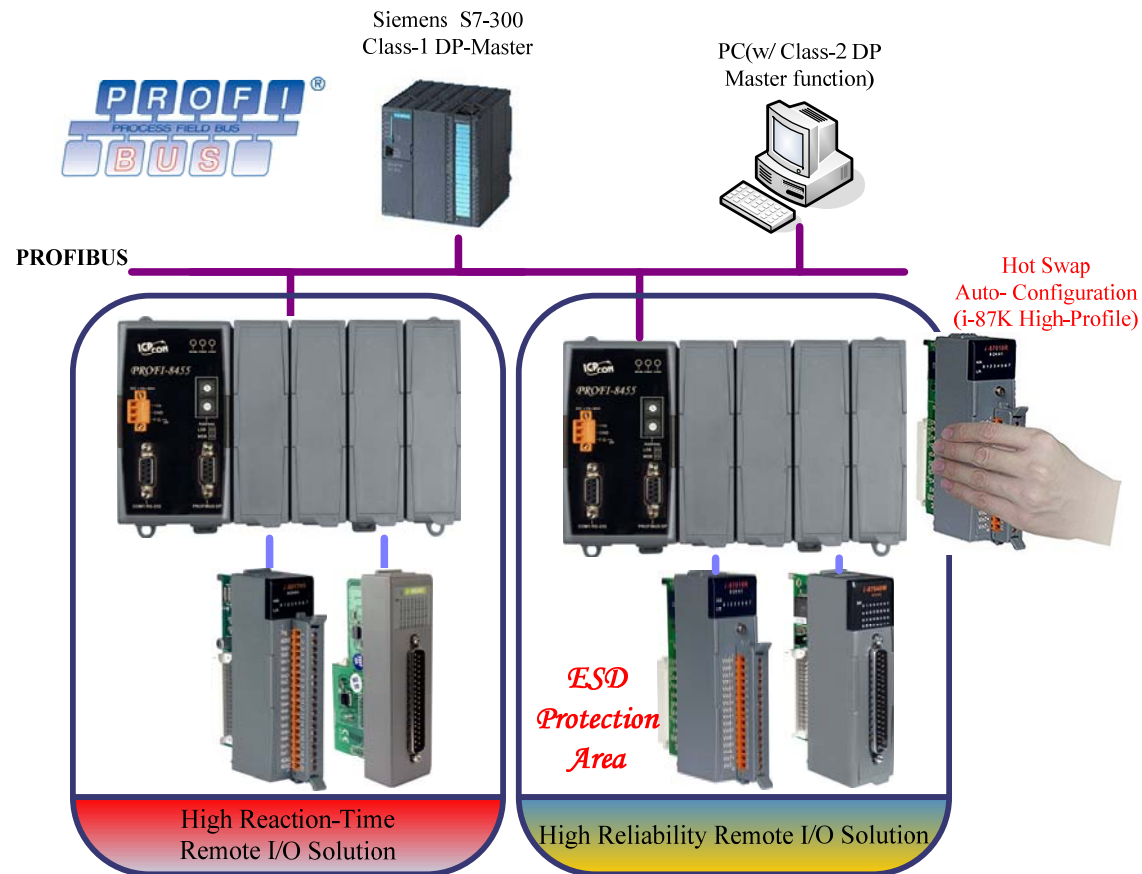

PROFIBUS Remote I/O Module

PROFIBUS Remote I/O Module	
PROFI-5045	24-channel Isolated DO Module
PROFI-5050	16-channel Non-Isolated DI and 8-channel Non-Isolated DO Module
PROFI-5051	24-channel Isolated DI Module
PROFI-5052	12-channel Isolated DI Module
PROFI-5053	24-channel Non-Isolated DI Module
PROFI-5055	8-channel Isolated DI and 8-channel Isolated DO Module
PROFI-5060	8-channel Isolated DI and 4-channel Relay Output Module
PROFI-5017	8-channel Isolated Analog Voltage Input Module
PROFI-5017C	8-channel Isolated Analog Current Input Module
PROFI-5024	4-channel Analog Voltage & Current Output Module



PROFIBUS Remote I/O Module

- **PROFI-5000 Series I/O Module**

Feature :

- **Support for PROFIBUS DP-V0 Slave**
- **Detect transmission rate automatically (Max. 12Mbps)**
- **Support device-related & channel-related diagnosis**
- **Address 0~126 set by rotary switches or SSA telegram**
- **3000VDC isolation protection on PROFIBUS**
- **4kV ESD protection (contact for any terminal)**
- **Wide range of power input (DC 10~40VDC) and operating temperature (-25°C~+75°C)**



PROFIBUS Remote I/O Module

- PROFI-5000 Series I/O Module

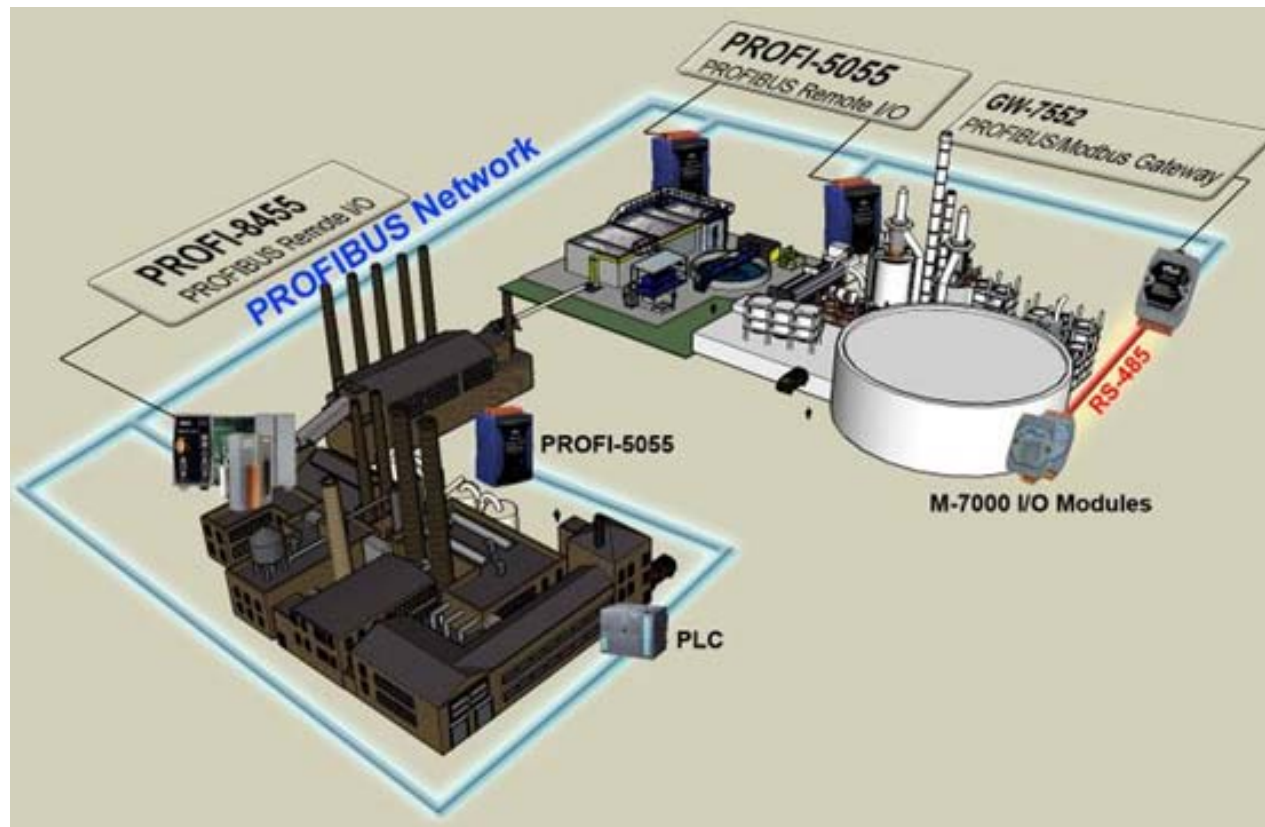

High protection and Certification

- DC/DC power supply to galvanically isolated bus drivers
- Photo-isolation protection on bus
- 4KV ESD protection
- CE, FCC certification

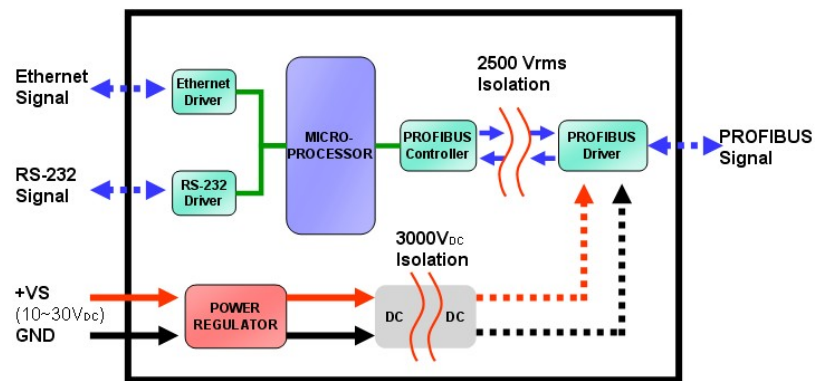

**ICP
DAS**

Industrial Computer Product Data Acquisition System

The Advantage in ICP DAS

- All kinds of PROFIBUS total Solutions
- PROFIBUS ODM products
- Good technology support Team



WIN-WIN



Best Service



Industrial Computer Product Data Acquisition System



Thank You

